

Operating Instructions

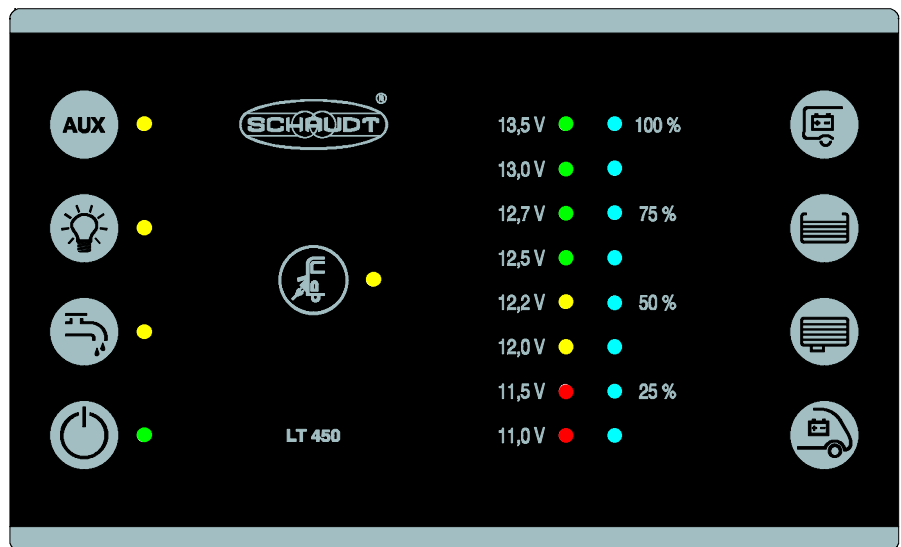

Operator and control panel LT 45X

Table of contents

1	Introduction	2
2	Application and function	5
3	Operation	6
3.1	Layout	6
3.2	Starting up	7
3.3	Switching on	7
3.4	Activating consumers	7
3.5	Checking battery voltage	8
3.6	Checking tank levels	9
3.7	Troubleshooting and remedies	10
3.8	Switching off	11
3.9	Closing down the system	11
4	Maintenance	11
	Appendix	12

1 Introduction

This instruction manual contains important information for the safe operation of equipment supplied by Schaudt.

The operating instructions should always be kept in the vehicle.



Configuration

▲ ATTENTION!



Failure to comply with the sign may result in damage to equipment or other connected loads.

LT 45X control panels differ as regards their configurations and the depiction of symbols.

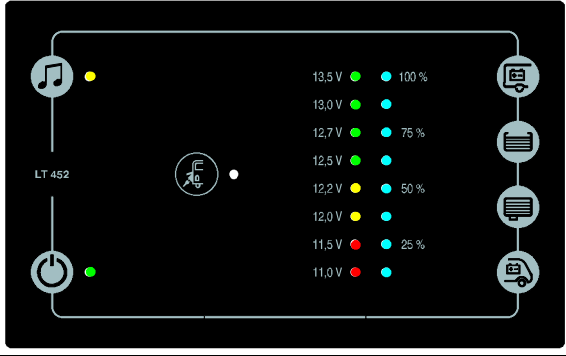

▲ This documentation covers all LT 45X control panels. The following table provides an overview of the configuration features.

Model	Front panel	12 V ON/OFF	Mains indicator	Voltage display Leisure area battery	Voltage display Starter battery	Fill level display Water tank	Fill level display Waste water tank	Pump switch	Light switch	AUX switch
LT450		X	X	X	X	X	X	X	X	X
LT451		X	X	X	X	X	X			
LT452		X	X	X	X	X	X			X

Model	Front panel	12 V ON/OFF	Mains indicator	Voltage display Leisure area battery	Voltage display Starter battery	Fill level display Water tank	Fill level display Waste water tank	Pump switch	Light switch	AUX switch
LT452*		X	X	X	X	X	X			X*
LT453		X	X	X	X	X	X	X		

Operating Instructions Operator and control panel LT 45X

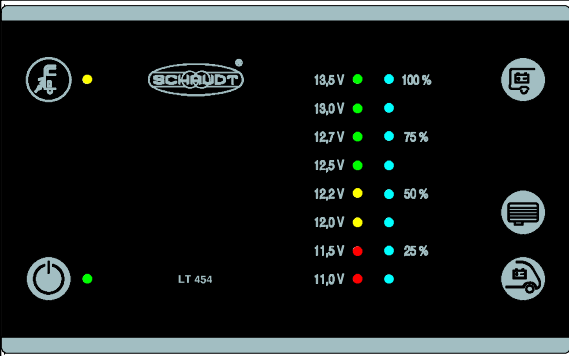
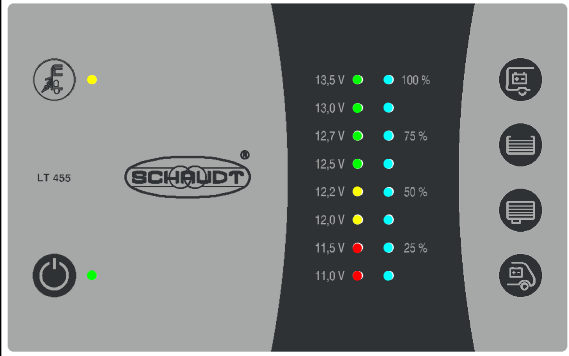
Model	Front panel	12 V ON/OFF	Mains indicator	Voltage display Leisure area battery	Voltage display Starter battery	Fill level display Water tank	Fill level display Waste water tank	Pump switch	Light switch	AUX switch
LT454		X	X	X	X		X			
LT455		X	X	X	X	X	X			

* Symbol "Multimedia" instead of AUX

2 Application and function

Purpose The LT 45X control panel is the central device for the EBL ... power supply, which powers all 12 V consumers in the vehicle's on-board electrical system. It is usually installed in an easily accessible place high up near the door of the vehicle.

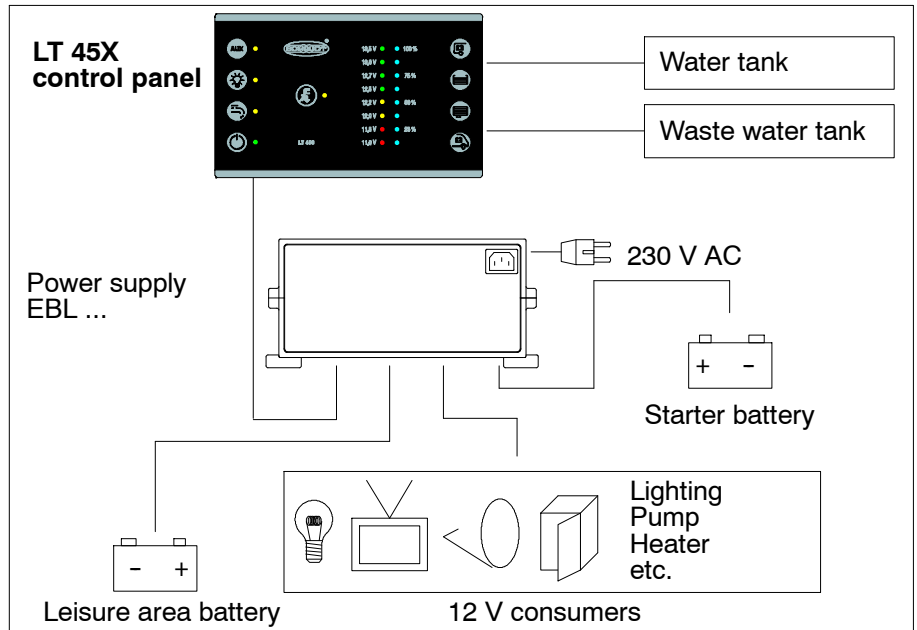

Fig. 1 On-board power supply system

The main layout of the on-board vehicle electrical system is shown in Fig. 1.

Function The functions of the LT 45X control panel are to switch on and off the 12V supply to the vehicle, and to display the battery voltage, tank levels and connection to the mains supply (230 V).

System devices An EBL ... power supply must be connected for operation. This provides the 12V supply to the devices in the vehicle and charges the battery.

The following connection options are available:

- EBL ... power supply
- Water tank probe
- Waste water tank probe or sensors

3 Operation

3.1 Layout

The LT 45X control panel is intended for installation in a cabinet or wall.

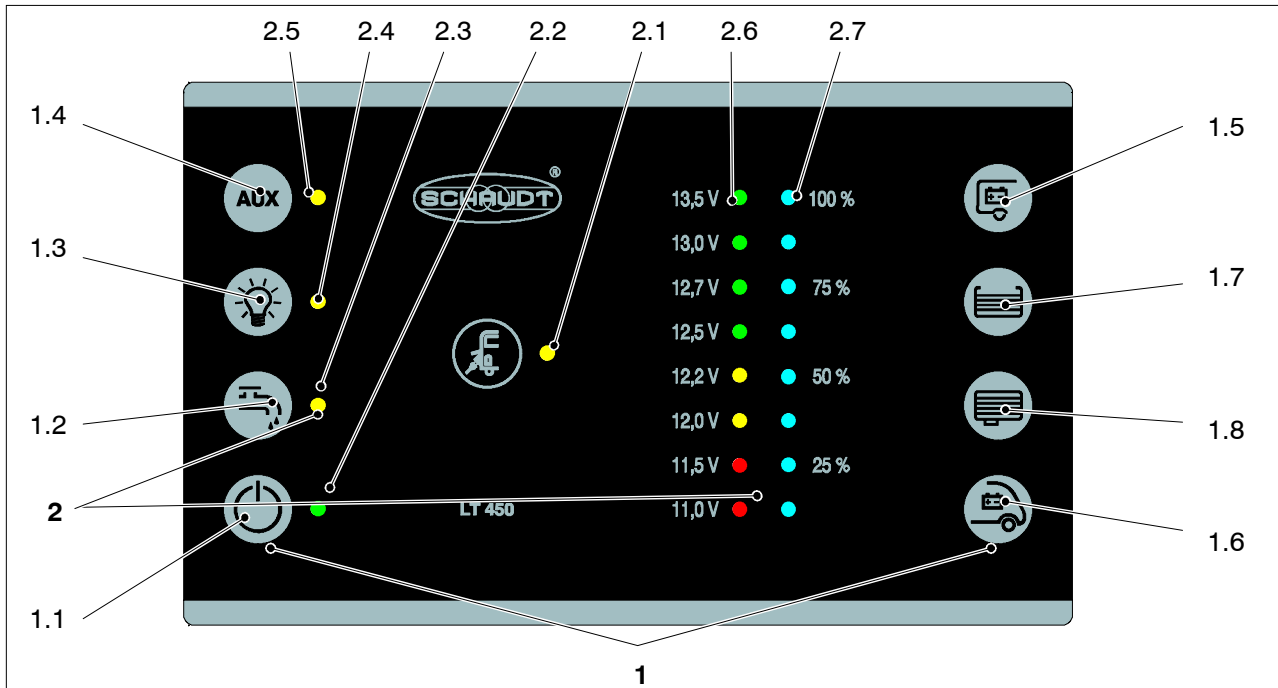

Fig. 2 Layout of LT 45X control panel

1	Touch sensor	2	Displays
-	-	2.1	LED mains indicator (yellow): The LED lights up when mains voltage is present at the input of the vehicle mains supply (also refer to the instruction manual for the relevant EBL ... , Section "Starting up").
1.1	Main switch, 12 V ON/OFF: For switching on and off the 12V supply of the vehicle	2.2	Indicator LED (green): Display: 12 V vehicle supply ON
1.2	Pump switch: For switching on and off the 12V supply for the water pump	2.3	Indicator LED (yellow): Display: Pump supply ON
1.3	Light power: For switching on and off the 12V supply for the leisure area lighting	2.4	Indicator LED (yellow): Display: Power for lighting ON
1.4	AUX supply: For switching on and off the 12 V AUX supply (e.g. for radio and TV)	2.5	Indicator LED (yellow): Display: AUX power ON
1.5	Check of leisure area battery voltage	2.6	8 LEDs (2 red - 2 yellow - 4 green): Display of battery voltage in 8 increments and warning of total discharge.
1.6	Check of starter battery voltage		
1.7	Check of water tank level	2.7	8 LEDs (blue): Display of water and waste water tank levels (four increments).
1.8	Check of waste water tank level		

General information on using the touch sensors

The LT 45X control panel has touch-sensitive sensors. These sensors react when touched with a bare finger. The LT 45X control panel cannot detect touches when gloves are worn (such as for camping in winter). Gloves must therefore be removed before use.

3.2 Starting up

230V mains operation

- ▶ Switch on the LT 45X control panel (see Section 3.3).
- ▶ Connect the input to the mains supply of the vehicle to the 230V mains supply.



Mains indicator LED lights up. The leisure area battery is being charged. For details on the charge functions, refer to the operating instructions for the relevant power supply (EBL ...).

3.3 Switching on

The 12V supply of the vehicle is switched on from the relevant button. The refrigerator controller is an exception. It also works when the 12V power supply is switched off – refer to the operating instructions for the relevant power supply (EBL ...).

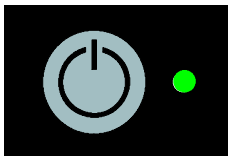

- ▶ Touch the sensor for the main 12V ON/OFF switch
 - The green indicator LED lights up
 - The 12V leisure area supply is switched on

3.4 Activating consumers

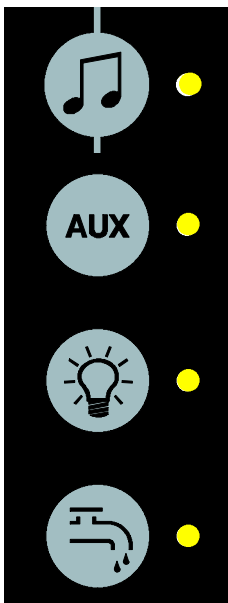

The following consumers are switched on and off by the LT 45X control panel (maximum configuration for LT 450, refer also to the table on Page 2):

- Water pump
 - Lighting
 - AUX or “Multimedia” (e.g. for radio or TV, refer also to the operating instructions from the vehicle maker).
- ▶ Touch the relevant sensor
 - The yellow indicator LED lights up
 - The relevant supply voltage is enabled
 - ▶ Touch the relevant sensor again
 - The yellow indicator LED goes out
 - The relevant supply voltage is disabled
- ▲ Switching on the water pump supply switches on a pressure pump connected (briefly as required).



3.5 Checking the battery voltage

3.5.1 Leisure area battery



► Touch the sensor for Check leisure area battery voltage.

The voltage of the leisure area battery is displayed:

- All LEDs light up: Battery charged sufficiently
- Yellow and red LEDs light up: Battery partially discharged (below 12.4V)
- Only red LEDs light up: Battery flat (below 11.5V)

The following table shows the correct interpretation of the voltage of the leisure area battery displayed on the scale.

These values apply to actual operation, not off-load voltage.

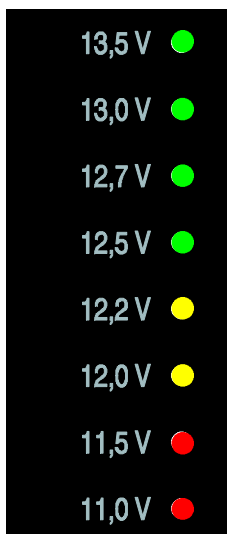

Battery voltage	Battery operation	Mobile operation	Mains operation
Lower than 11.5V Risk of total discharge	When consumers are switched off: Battery flat	The alternator is not charging the battery	No charging by the EBL ... power supply
	When many consumers are switched on: possible battery overload	12V power supply overloaded	12V power supply overloaded
12,2V to 12,7V	Normal range	No charging by the alternator ¹⁾	No charging by the EBL ... power supply ¹⁾
		12V power supply overloaded ¹⁾	12V power supply overloaded ¹⁾
13,5V	Only occurs during charging (only when there is a solar regulator) or momentarily after charging	Battery is charged	Battery is charged

¹⁾ If the voltage does not exceed this range for several hours.



▲ ATTENTION!

Total discharge results in damage to the leisure area battery:

- A low battery charge, indicated by low voltage, must be prevented.
- Switch off some consumers in the event of overloaded power supply.
- Prior to taking the vehicle out of service, ensure that no inactive consumers are still connected.

Off-load voltage

Measuring the off-load voltage is a simple and effective method of checking the condition of the battery. Off-load voltage is the voltage of the charged battery in a passive state, with no current being supplied or drawn.

Take the measurement several hours after the last charging. In the meantime, no significant load should be placed on the battery, meaning no current should be drawn from it. There is a risk of total discharge if the off-load voltage of the battery is 12.2V or lower.

The following table shows the correct interpretation of the off-load voltage displayed. The values specified are guidelines for gel batteries.

Values for off-load voltage	Charge state of the battery
12,0 V or lower	Discharged or totally discharged
12,2V	Approx. 25%
12,7V	Approx. 50%
More than 12.7 V	Full

3.5.2 Starter battery



► Touch the sensor for Check starter battery voltage.

The voltage of the starter battery is displayed.

3.6 Checking tank levels



► Touch Check tank level sensor:

- Water or



- Waste water

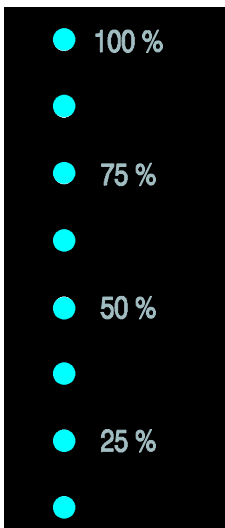

● The level of the relevant tank is displayed:

- Water: 100%, 75%, 50%, 25%;
The tank is empty if the 25% LED flashes.
- Waste water: 100%, 75%, 50%, 25%

3.7 Troubleshooting and remedies

3.7.1 Alarms















▲ ATTENTION!

Total discharge results in damage to the leisure area battery:

- A low battery charge, indicated by low voltage, must be prevented.
- Check the voltage regularly (see Section 3.5)



▲ It is best to carry out checks in the morning before 12V consumers are switched on.

Alarm	Possible cause	Remedy
12,7 V   75	When the system is switched off: - Voltage of the leisure area battery has fallen below 11.4V.	Switch off all 12V consumers.
12,5 V  		
12,2 V   50	With system switched on and check of leisure area battery voltage: - Voltage of the leisure area battery has fallen below 11.0V.	Charge the battery: - Start engine or - connect to 230V power supply
12,0 V  		
11,5 V   25	Applicable for both cases: Risk of total discharge of the leisure battery.	
11,0 V  		

3.7.2 Faults

Flat vehicle fuses

The majority of power supply system faults are caused by blown fuses (refer to the instruction manual for the relevant EBL ... / CSV ... power supply for information on voltage distribution and .

Please contact our customer service team if you cannot rectify a fault using the following table.

If this is not possible (such as when you are abroad), you can have the electrical vehicle system repaired at a specialist workshop. In this case, you must ensure that the warranty is not invalidated by incorrect repairs being carried out. Schaudt GmbH will not accept any liability for damage resulting from such repairs.

Fault	Possible cause	Remedy
12V supply does not function (or some areas are not powered).	12V main switch is switched off.	12V main switch must be switched on.
	Fuse blown.	Refer to the operating manual for the EBL... power supply . .
12V indicator LED (green) does not light up.	12V main switch is switched off.	12V main switch must be switched on.
	Leisure area battery not charged.	Charge the leisure area battery.
	Fuse blown.	Refer to the operating manual for the EBL... .

Fault	Possible cause	Remedy
Leisure area battery is flat.	Leisure area battery is discharged.	Immediately charge the leisure area battery. The leisure area battery is damaged beyond repair if left totally discharged for a lengthy period.
	The battery can be discharged by inactive consumers.	Fully charge the leisure battery before taking the motorhome out of service for a longer period.
The mains indicator LED (green) does not light up even though the 230V mains supply is connected.	The mains connection is dead.	Check the mains connection (e.g. camping site).
	Circuit breaker or earth leakage circuit breaker in the vehicle (in front of power supply) has triggered or is disabled.	Reset the vehicle circuit breaker or earth leakage circuit breaker.

3.8 Switching off



- ▶ Touch the sensor for the main 12V ON/OFF switch
 - The green indicator LED goes out.
 - The 12V leisure area supply is switched off.

The refrigerator controller is an exception. It also works when the 12V power supply is switched off, and as soon as a battery is connected or mains voltage applied.

3.9 Closing down the system

The system should be switched off if the vehicle is not being used for a lengthy period, such as during the winter.

- ▶ Disconnect the leisure area battery from the 12V on-board supply; to do this:
 - ▶ Disable the battery cut-off switch of the relevant power supply
 or
 - ▶ Disconnect the battery terminals (depending on power supply)
- ▲ Also refer to the operating manual for the relevant power supply (EBL ...).



4 Maintenance

The LT 45X control panel requires no maintenance.

Cleaning Clean the device with a soft, slightly damp cloth and mild detergent. Never use spirit, thinners or similar substances. Do not allow fluid to penetrate into the LT 45X control panel.

- © No part of this manual may be reproduced, translated or copied without express written permission.

Appendix

A Block diagram/wiring diagram

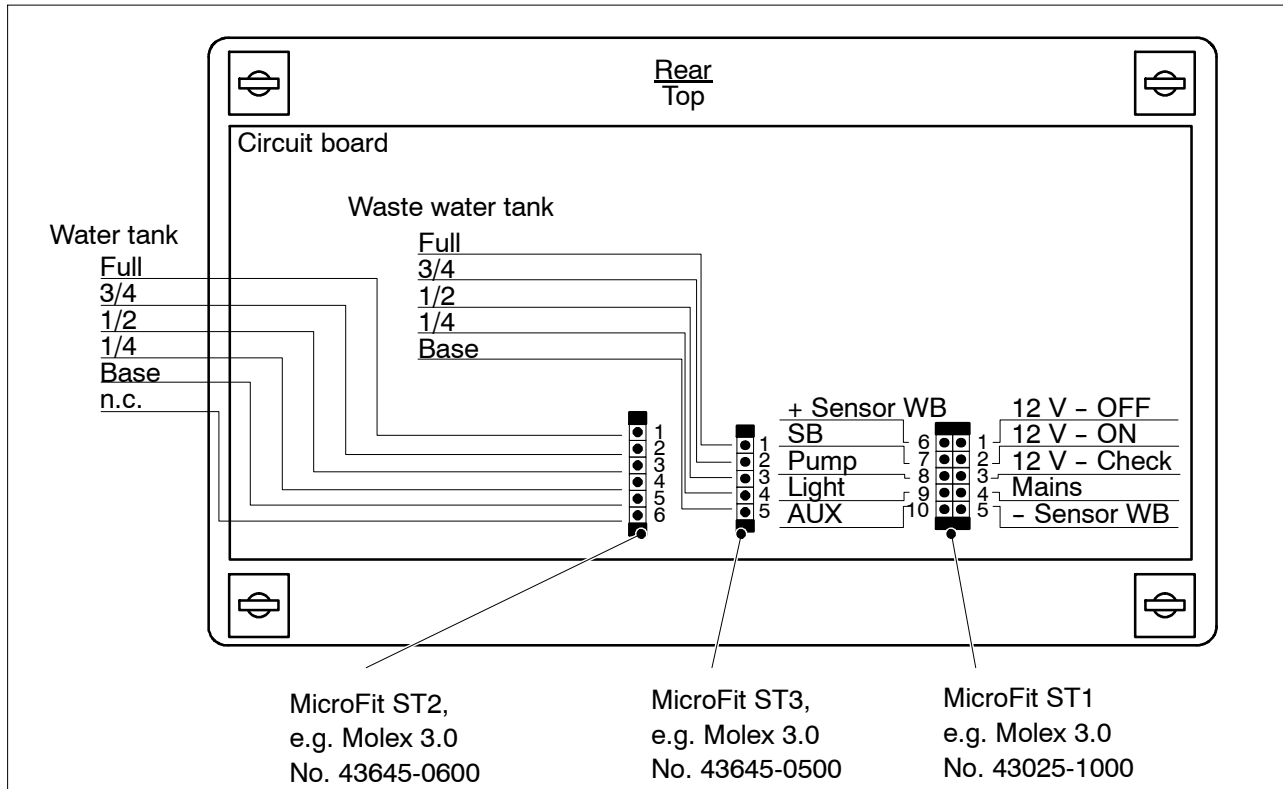

B Customer service

Customer service Schaudt GmbH, Elektrotechnik & Apparatebau
Planckstraße 8
88677 Markdorf, Germany

Phone: +49 7544 9577-16

Email: kundendienst@schaudt-gmbh.de

Web: www.schaudt-gmbh.de

Send in device Returning a faulty device:

- ▶ Complete and enclose the fault report, see Appendix C.
- ▶ Send it to the addressee (free delivery).

C Fault report

In the event of damage, please fill in the fault report and send it with the faulty device to the manufacturer.

Device type: _____
Item no.: _____
Vehicle: _____
Manufacturer: _____
Model: _____
Own installation? Yes No
Upgrade? Yes No

There is the following defect:
(please tick)

- Battery not being charged during power operation
- Battery voltage not displayed
- Electrical consumers do not work - which?
- General malfunction of switch panel
- Persistent fault
- Intermittent fault/loose contact

Other comments:

(Blank page)